

# 9AS Active

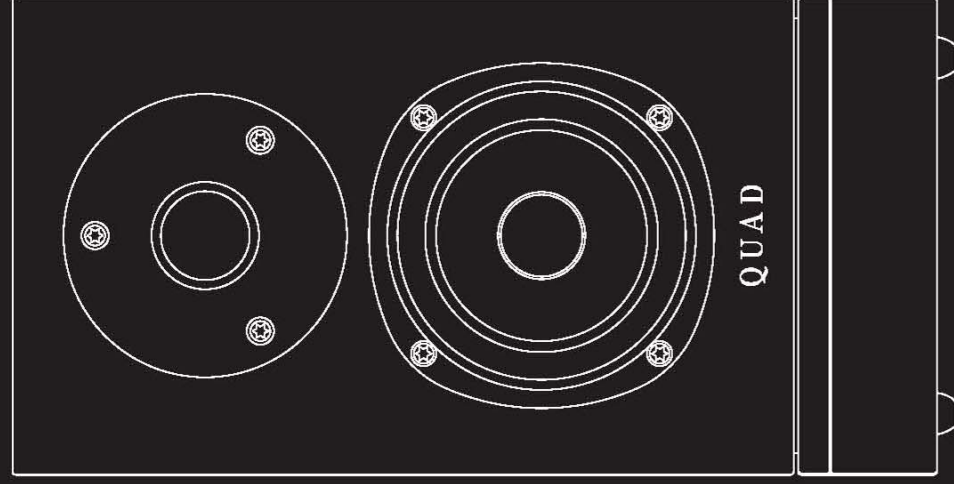

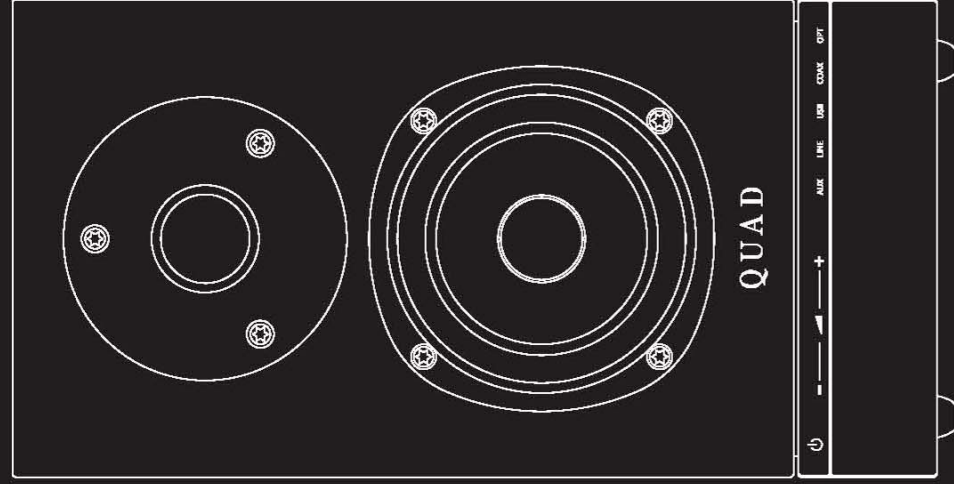

Owner's Manual

# QUAD

*the closest approach to the original sound*

## IMPORTANT SAFETY INFORMATION

	<b>CAUTION!</b> RISK OF ELECTRIC SHOCK DO NOT OPEN	
TO REDUCE THE RISK OF ELECTRIC SHOCK DO NOT REMOVE COVER (OR BACK) NO USER-REMOVABLE PARTS INSIDE REFER SERVICING TO QUALIFIED PERSONNEL		
ADVERTISSEMENT: RISQUE DE CHOC ELECTRIQUE- NE PAS OUVRIIR		



This symbol indicates that there are important operating and maintenance instructions in the literature accompanying this unit.



This symbol indicates that dangerous voltage constituting a risk of electric shock is present within this unit.

Read these instructions.

Keep these instructions.

Heed all warnings.

Follow all instructions.

Do not use this apparatus near water.

Clean only with dry cloth.

Do not block any ventilation openings.

Install in accordance with the manufacturer's instructions.

Do not install near any heat sources such as radiators, heat registers, stoves, or other apparatus (including amplifiers) that produce heat.

Do not defeat the safety purpose of the polarised or grounding type plug.

A polarised plug has two blades with one wider than the other. A grounding type plug has two blades and a third grounding prong. The wider blade or the third prong is provided for your safety. If the provided plug does not fit into your outlet, consult an electrician for replacement of the obsolete outlet.

## ELECTRICAL INFORMATION

### MAINS SUPPLY AND SAFETY

**Mains Supply:** The mains operating voltage of all QUAD Platinum series units is shown on the rear panel. If this voltage does not match the mains voltage in your area, consult your QUAD dealer about converting the unit.

The mains supply fuse on the rear panel is accessible when the IEC mains plug has been removed. In the rare event that it has broken, check for any obvious cause before replacing the fuse with one of the correct rating and type. The fuse values are:

#### QUAD 9AS ACTIVE

100 – 120V(USA,Japan,etc) T4.0AL 250V  
220 – 240V(UK,China,etc) T2.0AL 250V

**Note:** The means of disconnecting this equipment from the mains supply is the ON/OFF switch on the rear panel. This should be freely accessible and operable at all times.



This equipment is a Class II or double insulated electrical appliance. It has been designed in such a way that it does not require a safety connection to electrical earth.

Protect the power cord from being walked on or pinched, particularly at plugs, convenience receptacles, and the point where they exit from the apparatus.



Use only attachments/accessories specified by the manufacturer.

Use only with a cart, stand, tripod, bracket, or table specified by the manufacturer, or sold with the apparatus. When a cart is used, use caution when moving the cart/apparatus combination to avoid injury from lip-over.

Unplug this apparatus during lightning storms or when unused for long periods of time.

Refer all servicing to qualified service personnel. Servicing is required when the apparatus has been damaged in any way, such as power-supply cord or plug is damaged, liquid has been spilled or objects have fallen into the apparatus, the apparatus has been exposed to rain or moisture, does not operate normally, or has been dropped.

**Warning:** To reduce the risk of fire or electrical shock, do not expose this product to rain or moisture. The product must not be exposed to dripping and splashing and no object filled with liquids such as a vase of flowers should be placed on the product.

No naked flame sources such as candles should be placed on the product.

**Caution:** Changes or modifications not expressly approved by the manufacturer could void the user's authority to operate this device.

This equipment has been tested and found to comply with the limits for a Class B digital device, pursuant to part 15 of the FCC rules. These limits are designed to installation. This equipment generates, uses and can radiate radio frequency energy and, if not installed and used in accordance with the instructions, may cause harmful interference to radio or television reception, which can be determined by tuning the equipment off and on, the user is encouraged to try to correct the interference by one or more of the following measures:

**Re-orientate or re-locate the receiving antenna.** Increase the separation between the equipment and the receiver. Connect the equipment into an outlet on a circuit different from that to which the receiver is connected.

Consult the dealer or an experienced radio/TV technician for help.

## IMPORTANT NOTICE TO UK USERS

The appliance cord is terminated with a UK approved mains plug fitted with a 5A fuse. If the fuse needs to be replaced, an ASTA or BSI approved BS1362 fuse rated at 5A must be used. If you need to change the mains plug, remove the fuse and dispose of this plug safely immediately after cutting it from the cord.

### Connecting a Mains Plug

The wires in the mains lead are coloured in accordance with the code: Blue: NEUTRAL; Brown: LIVE; Green and Yellow: Earth. As these colours may not correspond to the coloured markings identifying the terminals in your plug, proceed as follows:

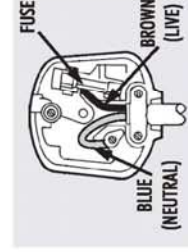

The BLUE wire must be connected to the terminal marked with the letter N or coloured BLUE or BLACK. The BROWN wire must be connected to the terminal marked with the letter L or coloured BROWN or RED.

---

# QUAD

## 9AS ACTIVE

### USER GUIDE

#### CONTENTS

SAFETY CAUTIONS.....	INSIDE FRONT COVER
MAINS SUPPLY AND SAFETY .....	INSIDE FRONT COVER
INTRODUCTION.....	2
PRODUCT REGISTRATION AND WARRANTY .....	2
UNPACKING THE EQUIPMENT .....	2
CONTROLS AND CONNECTIONS .....	3
POSITIONING YOUR LOUDSPEAKERS .....	4
INSTALLATION .....	5
SIGNAL CONNECTIONS TO THE MASTER SPEAKER .....	6
TRIGGER CONNECTIONS OF MASTER AND SLAVE .....	7
SIGNAL CONNECTIONS OF MASTER AND SLAVE .....	8
KEY FUNCTIONS ON FRONT PANEL .....	8
REMOTE HANDSET .....	9
USB DRIVER INSTALLATION.....	10
SPECIFICATIONS .....	19
CARE AND CLEANING .....	20



---

## INTRODUCTION

Congratulations on purchasing this new QUAD Active Loudspeaker System.

9AS is a dedicated Active Speaker design featuring a refined treble unit with associated waveguide front plate coupled to the classic Quad woven Kevlar bass unit, both driven by low distortion Class AB amplifiers via a sophisticated active crossover.

The 9AS Active mini-monitor is, of course, ideally suitable for near field monitoring in the studio as well as part of a home hi-fi system. But 9AS offers more than just a standard active speaker. Look behind and you'll find inputs for a variety of digital sources making 9AS compatible with CD players, computers, smartphones as well as analogue sources. Switching between these inputs is handled simply by touching the requisite symbol on the front panel or via the remote control.

An ultra high performance DAC, as found on Quad's Elite CD players, resolves digital inputs with up to 24 bit/192kHz accuracy. USB, Coaxial and Optical digital inputs allow a variety of ways to connect and switch between your digital sources.

## PRODUCT REGISTRATION AND WARRANTY

QUAD equipment is guaranteed against any defect in material and workmanship for a period of one year from the date of purchase. Proof of purchase is required for Warranty claims.

Please complete and return the enclosed Warranty Registration form.

Within the warranty period QUAD will undertake replacement of defective parts free of charge provided that the failure was not caused by misuse, accident or negligence.

Your statutory rights within the territory in which you purchased the equipment are not affected by this warranty.

QUAD carries out regular reviews and reserves the right to adjust the specifications and performance from time to time.

## UNPACKING THE EQUIPMENT

- The 9AS Active Master speaker
- The 9AS active Slave speaker
- Two IEC mains cable with a plug suitable for your area
- Remote Handset with battery
- 9AS Active Instruction Manual
- Warranty Registration Form
- One USB Cable
- One Trigger Line
- CD-ROM –Quad XU1 Audio Driver
- One RCA Cable

Consult the dealer from whom you purchased the equipment if any item is not present.

Carefully unpack the unit and accessories. Take care not to damage the surface finish when undoing the protective polythene sleeve. Retain the packing materials for future use.

Retain the user manual and information concerning the date and place of purchase of your equipment for future reference.

If you transfer any unit to a third party please pass on this instruction manual along with the equipment.

# CONTROLS AND CONNECTIONS

Master

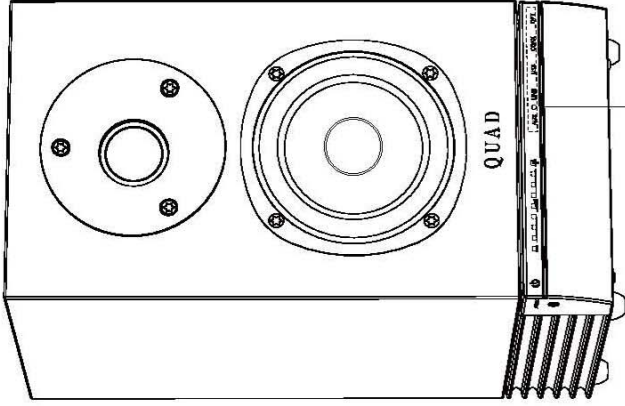

Slave

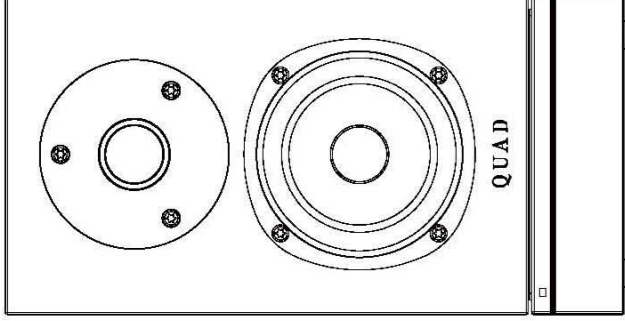

AUX INPUT VOLUME DOWN  
STANDBY VOLUME UP  
IR SOURCE

STANDBY

OUTPUT TO SLAVE

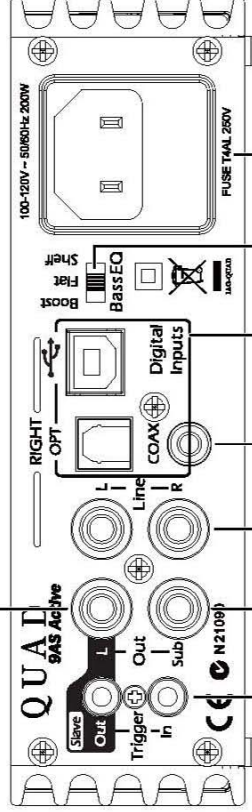

TRIGGER SUBWOOFER ANALOG OPT INPUT  
IN/OUT OUTPUT INPUT COAXIAL INPUT

DIGITAL INPUT

EQ SELECT

POWER

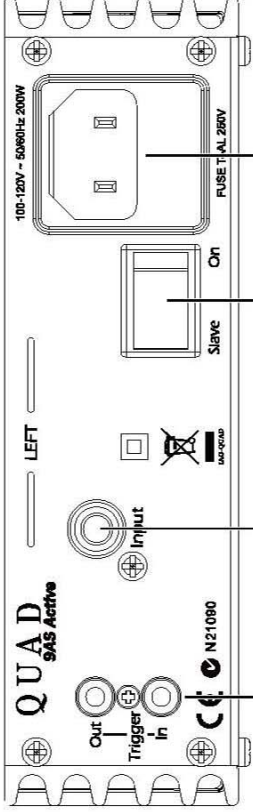

TRIGGER IN/OUT

SLAVE INPUT

SLAVE MODE

POWER

---

## POSITIONING YOUR LOUDSPEAKERS

### HIFI STEREO OPERATION

For standard Stereo applications the loudspeakers should be mounted on a stable surface such as a wall shelf, floor stands or table 1-1.5 meters above the floor, central to the listening position. For remote operation there must be a clear line of sight between the listener and the Master (Right) loudspeaker.

9AS bass extension depends on proximity to a wall (see Bass EQ selection). Note that the speakers should be kept clear of room corners and the finned amplifier heatsinks should not touch a rear wall and should be away from any delicate wall coverings or fabrics that may be affected by heat. Ideally the top of the loudspeakers should be at ear level to a seated listener, though this may not always be possible. Facing the loudspeakers slightly inward can improve stereo imaging.

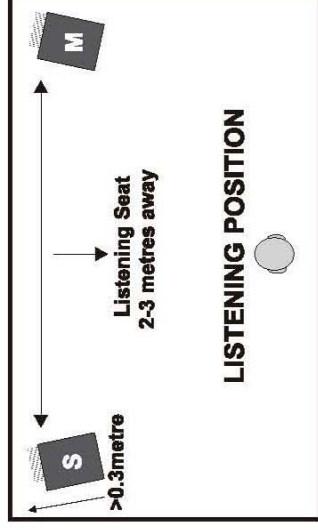

### THE LOUDSPEAKERS AS NEAR-FIELD MONITORS

Place the loudspeakers on a stable surface such as a wall shelf or table where they are unlikely to be knocked over and central to the listening position. Ensure the finned amplifier heat sinks are clear of the wall and any other delicate surfaces. For reliable remote operation there must be a clear line of sight between the listener and the Master (Right) loudspeaker.

If the loudspeakers can not be placed at ear level to a seated listener, they may be angled a few degrees up or down as necessary.

If you are using the system with a game console, avoid placing the loudspeakers on the floor.

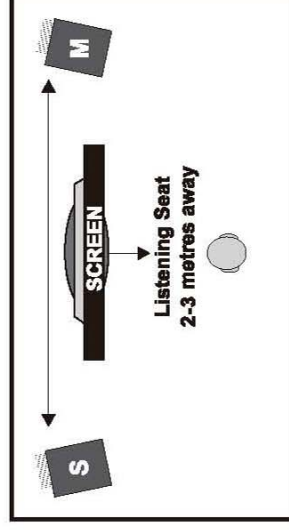

*The above are our recommendations. Be prepared to experiment until you have the setup that is right for you.*

---

## CONNECTING YOUR LOUDSPEAKERS

*Always make connections with all system units switched off.*

## INSTALLATION

Before making any connections to your high fidelity equipment make sure that all units in the system are switched off and unplugged at the mains.

### Mains Connections

Before connecting your QUAD equipment to the AC mains supply check that the voltage marked on the back matches the voltage supply of your area.

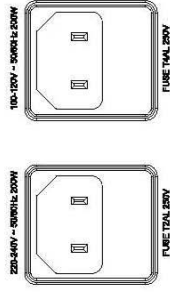

### Mains On/Off Switch

The product will enter standby after being powered on. When the product is connected to a source unit using the triggers inputs, this switch should be left switched on as the speaker will be remotely switched by other source units. When 9AS is not part of a trigger enabled system, the Mains On/Off Switch should be switched off when the speakers are not in use. Please unplug power cord if the speakers are not be used for a long time.



---

## SIGNAL CONNECTIONS TO THE MASTER SPEAKER

QUAD 9AS can play USB, optical and coaxial 3 digital and analog signals by connecting signal cable to corresponding input port. 9AS's DAC can convert digital signal with sampling rateup to 192KHz. When you use the remote control or front panel to select any digital inputs, the inputs light will blink three times and then stop if no valid digital signal input or if the signal interruption while playing.

### Bass EQ Selections

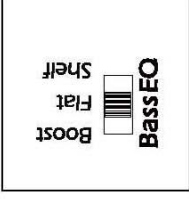

9AS has three options for Bass EQ setting: "**Boost**", "**Shelf**", and "**Flat**". Users can adjust the **Bass EQ** switch to strengthen (**Boost**), reduce (**Shelf**) or maintain a **Flat** bass response as required. "**Flat**" gives a natural sounding response with optimal bass definition. "**Shelf**" may be selected if the speakers are mounted on a shelf or table close to a rear wall. "**Boost**" may be selected where extra bass output is required, for example where the speakers are free standing on floor stands.

### Analog Inputs

Two analog inputs are available. The **Line** input on the rear panel accepts RCA Phono plugs. The **Aux** input on the side panel accepts a 3.5mm stereo jack, for example from a portable music player.

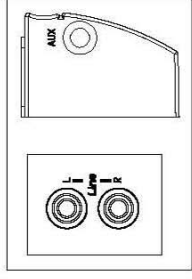

### Digital Inputs

Digital inputs can be connected to the rear panel sockets for Optical, USB and Coaxial connections.

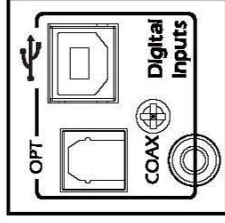

### Out\_Sub

If required a subwoofer can be added to extend the low frequency performance of the 9AS loudspeakers using this output. Use an RCA Phono to Phono cable to connect this output to the Line input of the subwoofer. The subwoofer output is filtered to suit the bass response of the 9AS in the "**Flat**" Bass EQ position.

### SUBWOOFER

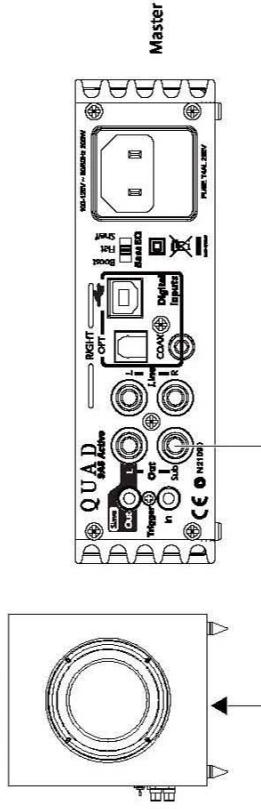



## TRIGGER CONNECTIONS OF MASTER AND SLAVE

Both speakers can be powered on/off mutually by trigger in and out.

Option 1, Master to control Slave: Plug one end of the trigger line cable into Master's Trigger out, connect the other end into the Slave's Trigger in, and turn **Slave/On** switch to **SLAVE**, then Slave speaker will automatically be powered on/off when Master speaker is turned on/off.

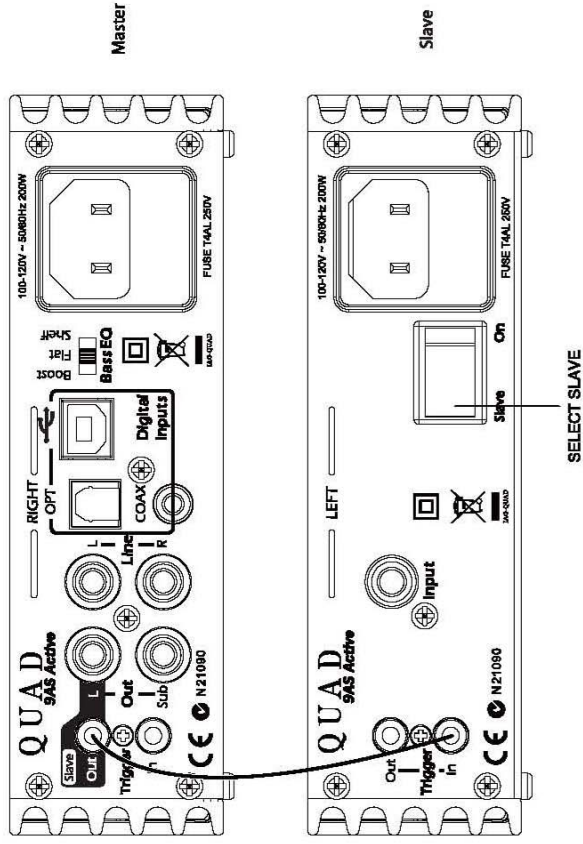

Option 2, Slave to control Master: Plug one end of the trigger line cable into Slave's Trigger out, connect the other end into the Master's Trigger in, and turn **Slave/On** switch to **On**, then Master speaker can be powered on when Slave speaker powers on, say from a Source trigger command.

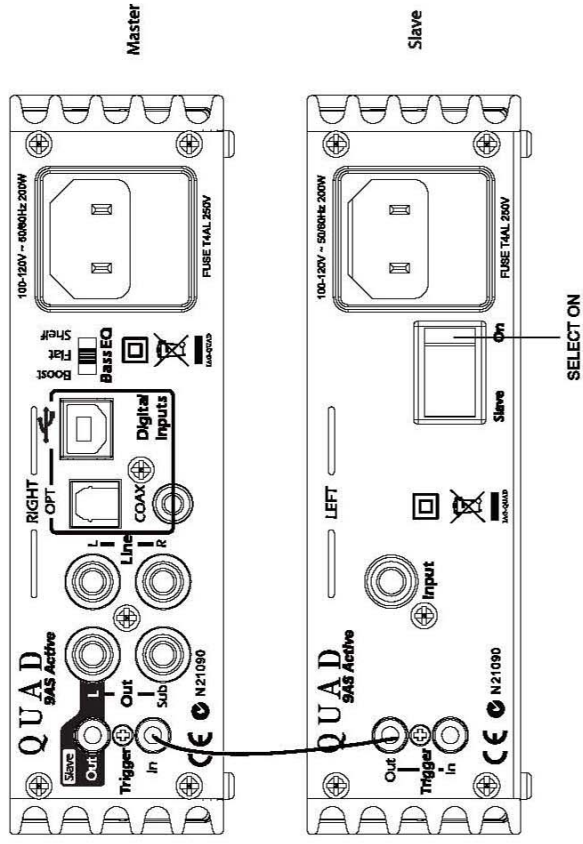

## SIGNAL CONNECTIONS OF MASTER AND SLAVE

For the Stereo connection, plug one end of the audio RCA cable to Master's **OUT\_L**, plug the other end of the audio RCA cable into Slave's Input.

Note: the Master speaker is designated as the Right speaker when facing the speakers and the Slave is the Left speaker for accurate stereo positioning.

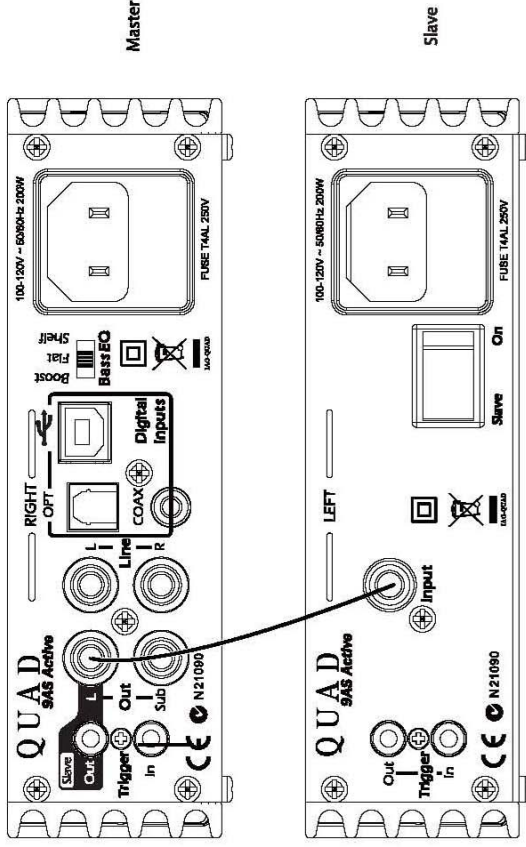

## KEY FUNCTIONS ON FRONT PANEL

Panel buttons are touch sensitive and will switch on when you place a finger over the correct area.

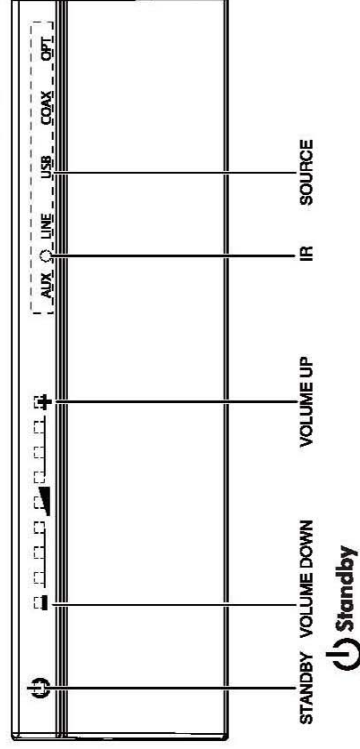

Touch **Standby** button to bring 9AS in/out of standby. When Master speaker is out of standby mode on switched on, the button light is lit. When 9AS is in standby mode, the button light is off.

**Volume Up/Down**

Touch +/- buttons to increase or decrease volume, both short and long press are valid. When volume decreases, lights will become darker gradually towards the "-" direction until all are off at minimum volume. When volume increases, the lights will become lighter towards the "+" direction until all are on at maximum volume. Note: Please turn down the volume if sound becomes distorted.

### Source Selection

- AUX** Touch to select AUX input, AUX will light up.
- LINE** Touch to select Line input, LINE will light up.
- USB** Touch to select USB input, USB will light up.
- COAX** Touch to select Digital Coax input, COAX will light up.
- OPT** Touch to select OPT input, OPT will light up.

## REMOTE HANDSET

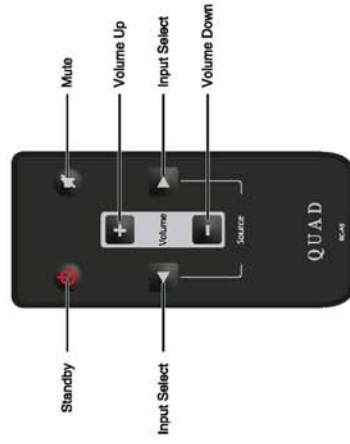

Press to bring product in/out of standby.



Press to Mute/Unmute the sound. In Mute the display front panel lights will go out and only the first LED will flash to indicate the speaker is in Mute mode. Front panel display shows the volume setting in Unmute mode.



Press to increase volume



Press to decrease volume



Press to select next source



Press to select previous source

## PREPARING THE REMOTE HANDSET

- Unpack the handset
- There is a small tab at the rear of the handset to protect the battery during transit. Remove this tab by gently pulling it out. The handset is now ready for operation.
- The handset uses a CR2025 battery. This will eventually run out and need replacement.

### Replacing the handset battery

- Invert the handset
- Press the catch inward
- Slide the tray out
- Remove the old battery
- Replace with a new CR2025 battery
- Close the battery tray

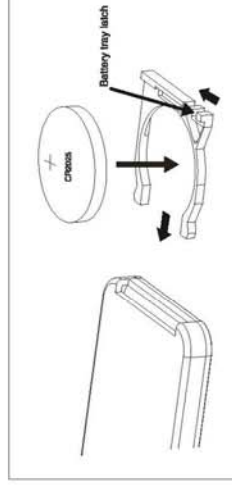

### Battery Cautions:

- There is a risk of fire and burns if the battery is handled improperly.
- Do not disassemble, crush, puncture, short external contacts, or dispose of in fire or water.
- Do not attempt to open or service the battery. Replace only with a CR2025 battery.
- Discard used batteries in accordance with recycling regulations in force in your area.

---

## USB DRIVER INSTALLATION

When using a PC, computer or laptop as the audio source, you will need to install a USB driver. The installation steps are as follows:

### All Operating Systems

Please note that your screen display may vary depending on the operating system.

#### System Requirements:

Intel Core 2 @ 1.6GHz or similar AMD processor  
1GB RAM  
USB 2.0 interface  
Microsoft Windows Vista 32/64 Bit incl. SP2 | Windows 7 32/64Bit | Windows XP SP3 (not recommended)  
Apple MAC OS from 10.6.4

### Mac OS X from 10.6.4 Installation

The driver will be installed automatically when USB-device is connected for the first time. No third party driver is required.





- 1 Select device QUAD USB 2.0 Audio Out.
- 2 Check Use this device for sound output.
- 3 Set your desired sample rate and bit resolution at Format.

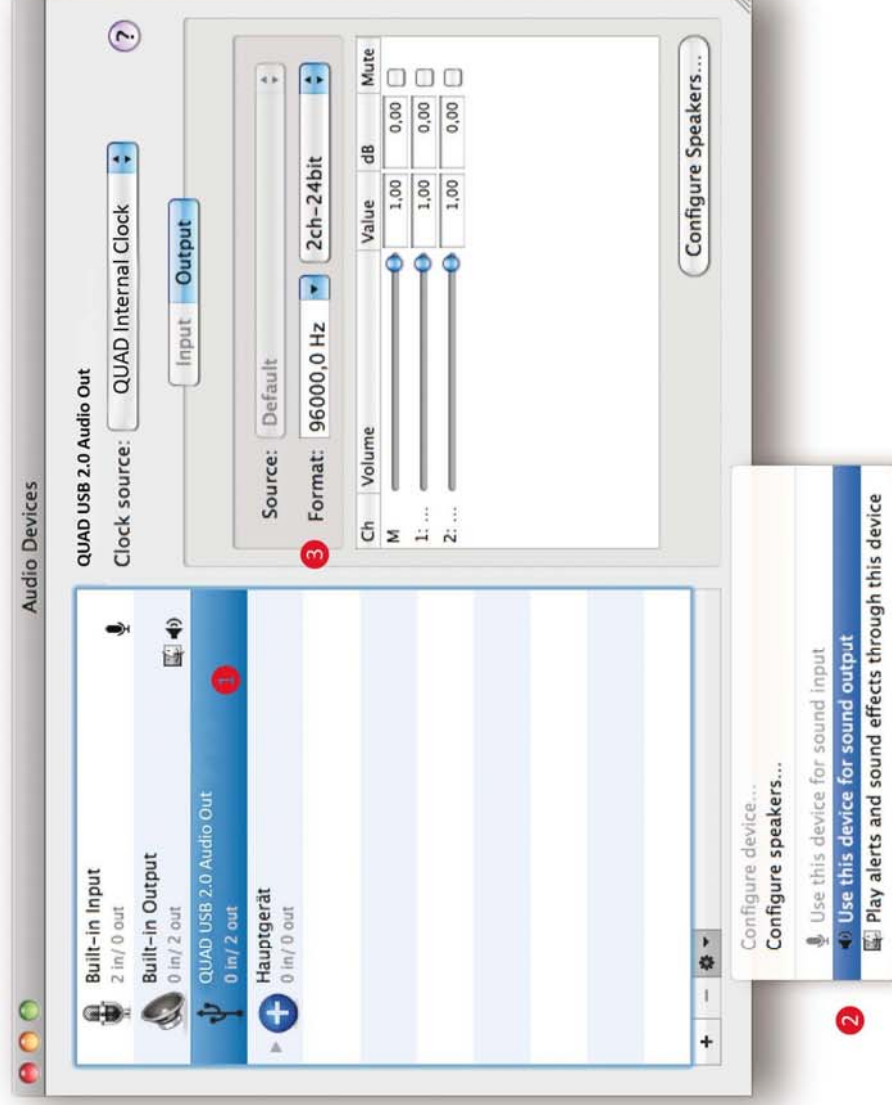

---

## Windows 7 / Vista / XP Installation

You have to install the driver before using the USB device for the first time!

Put the installation CD into the CD/DVD drive of your computer.

Setup will start automatically. If not, please follow these steps:

Click on Start -> Computer. Right-click the icon of the CD/DVD drive and then click on Install program.  
Follow the instructions of the setup program to install the driver. Complete the installation by clicking Finish.

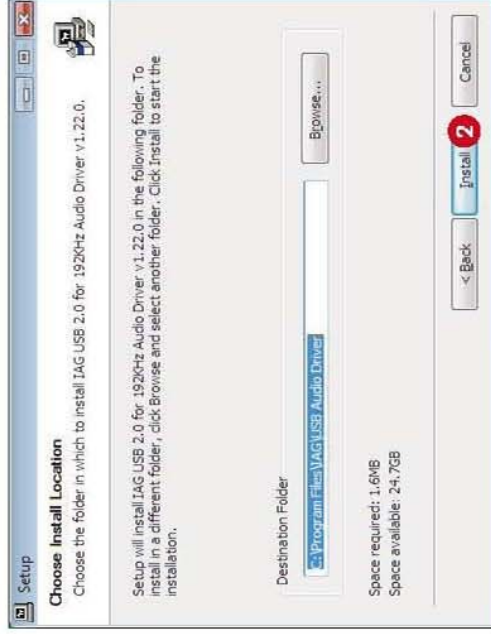

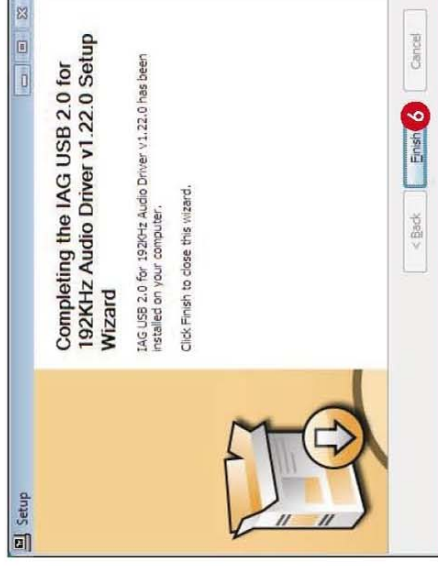
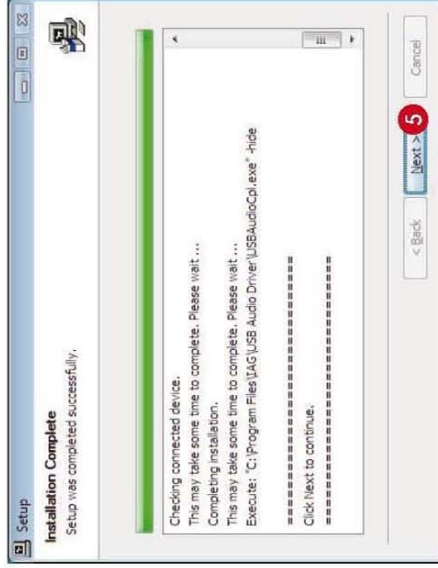
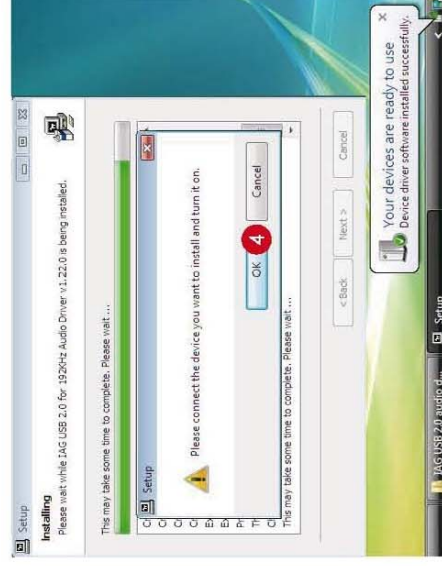





To confirm connection of the Quad 9AS Active to the PC, double click on the  tab.

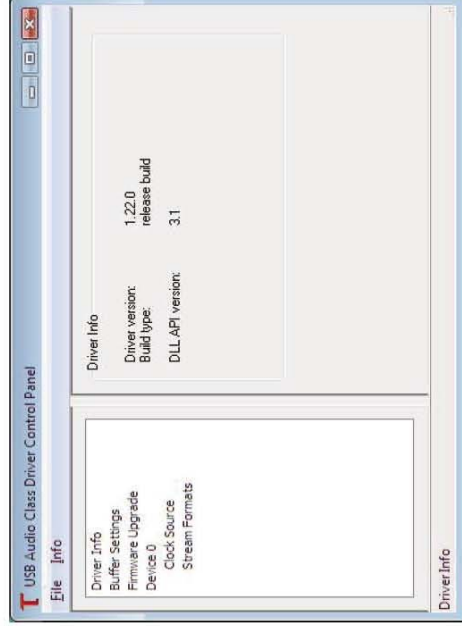

If this window appears then the connection has been established between the Quad 9AS Active and the PC, the device is now ready to use.

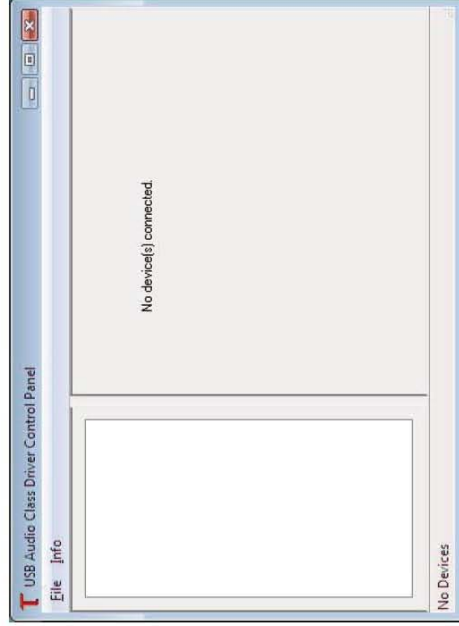

If this window appears then the connection has not been established, please reconnect the Quad 9AS Active.

---

## Windows 7 / Vista / XP System Setup

After successful installation of the driver please connect the USB audio device to a free USB port. Do not use a USB-hub! Close all other USB applications if you want to listen to music with your computer. The Quad XU1 Audio Driver replaces the internal soundcard of your computer.

### Adjusting the Sample Rate

- 1 Open the control panel of your computer.
- 2 Open Sound.
- 3 If the Quad XU1 Audio is not set to default, please set it to default as shown.



4 Under properties select Advanced and adjust the output format as required 5.

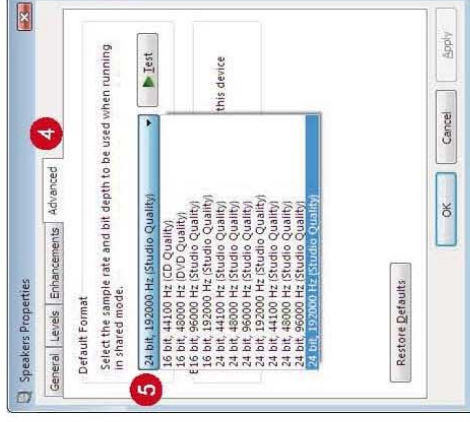

**Note:**

Windows Vista does not support the sample rate of 176.4kHz/24 bit. If you want to playback this sample rate, a music player supporting this feature is required. You can use J. River Media Center or Foobar for example. Windows XP does not support sample rates of more than 48 kHz. You need a special music player to play back other sample rates, for example J. River Media Center or Foobar.

---

## Recommendations

Music players supplied with Windows or Mac OS do not support "native" playback of music files. If you adjust the output sample rate to 96 kHz for example, but your file is 44.1 kHz, the computer will convert the sample rate to 96 kHz. This will affect sound quality and should be avoided! In order to get native playback you must install a music player which supports this feature. Automatic sample rate detection and switching is also a useful feature. We achieved very good results with these players:

### MAC

#### Pure Music Player + iTunes

- + better sound quality compared to iTunes
- + automatic sample rate switching
- + Memory buffered playback
- + 64 bit precise up-sampling
- + exclusive access
- + Plug-ins

### Windows

#### J. River Media Center 16

- + sound quality
- + automatic sample rate switching
- + Plug-ins

## Attention Before Service

If the above operations fail to work, please try the following illustrations.

1. Please connect the power cable or power adapter before plugging USB cable to your PC.
2. Please unplug and reconnect the power cable or USB cable when the PC does not recognize the device / when it works abnormally.
3. Please disconnect the power cable and USB cable when unused for a long time.

\* Should the above symptoms persist with all instructions observed, your 9AS Active USB D/A Converter may require servicing.



---

## SPECIFICATIONS

### General description

#### Design philosophy and core technology

2-way bookshelf active speaker  
Digital input(USB+optical+coaxial)  
Supports sampling frequencies up to 24 bit/192kHz  
Analog input (RCA Line+3.5mm AUX IN)

#### Enclosure type

#### Midbass driver

#### Treble driver (High frequency driver)

#### AV shielded

#### Input sensitivity

#### Rated power output

#### Peak power output

#### Standby power

#### Peak SPL

#### Frequency response (+/-3dB)

#### Bass extension (-6dB)

#### Crossover frequency

#### Cabinet volume

#### Dimensions (H x W x D)

#### Net weight

100mm woven Kevlar cone

25mm fabric dome

No

400mV

65W LF + 35W HF

130W LF + 70W HF

0.5W

110dB

65Hz ~ 23kHz

47Hz

2.5kHz

4.3L

302 x 152 x 215 (mm)

9.4kg

---

## CARE AND CLEANING

The surface of the speaker should be wiped occasionally with a barely damp soft cloth. The grille cloth may be cleaned with a soft brush or a hand held vacuum cleaner. The loudspeaker are protected against the ingress of dust etc. Periodic servicing of two year intervals is recommend to keep your speakers in pristine condition. Great care has gone into the selection of materials to ensure long term stability under a wide range of temperature and humidity. In countries where the relative humidity regularly exceeds 90% it is recommend that the listening room be air conditioned for optimum performance.

Caution: SWITCH THE LOUDSPEAKERS OFF AND DISCONNECT THEM FROM THE MAINS BEFORE CLEANING.

### Servicing

If your Quad equipment requires servicing you should return it to the cleaner from whom the equipment purchased. If you are abroad and there is no suitable dealer in your area, please contact the distributor for the country in which was the purchase or Quad Electroacoustics Ltd. Equipment returned for the service should use the original packing. You should enclose a brief note with your name and address and the reason for returning the equipment.

### Warranty

Your Quad equipment is guaranteed against any defect in material and workmanship for one year from the date (proof of purchase required). We ask you to complete and return the enclosed Warranty Registration form(UK). This will also enable us to keep you informed of future Quad products. Within the guarantee period, Quad will undertake replacement of defective parts free of charge provided the equipment are not affected by this guarantee. Quad carries out a regular review of its products and reserves the right to adjust the specification and performance from time to time.

There are no user replaceable or serviceable parts inside this equipment. Unauthorised attempts to service or modify this product will invalidate the warranty.

### Service Center Address

IAG Service Dept. Unit 4 St Margaret's Way Stukeley Meadows Industrial Estate, Huntingdon, Cambs, PE29 6EB, England  
Tel: +44(0) 1480 452561 Fax: +44(0) 1480 413403



**Correct disposal of these products.** This mark indicates that this product should not be disposed with other household wastes throughout the EU. To prevent possible harm to the environment or human health from uncontrolled waste disposal, recycle it responsibly to promote the sustainable reuse of the material resources. To return your used device, please use the return and collection systems or contact the retailer where the products was purchased. They can take this product for environmentally safe recycling.

Q U A D

IAG House, Sovereign Court, Ermine Business Park, Huntingdon, Cambs, PE28 6XU, UK

Tel: +44(0)1480 447700 Fax: +44(0)1480 431767 <http://www.quad-hifi.co.uk>

IAG reserves the right to alter the design and specifications without notice. All rights reserved © IAG Group Ltd.

Quad is a member of the International Audio Group. Code: QH12-MNL006a